

Linear Direct Pendant, Flush Snap-in Lens

T5

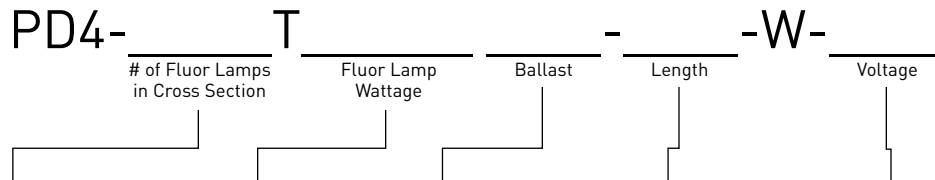
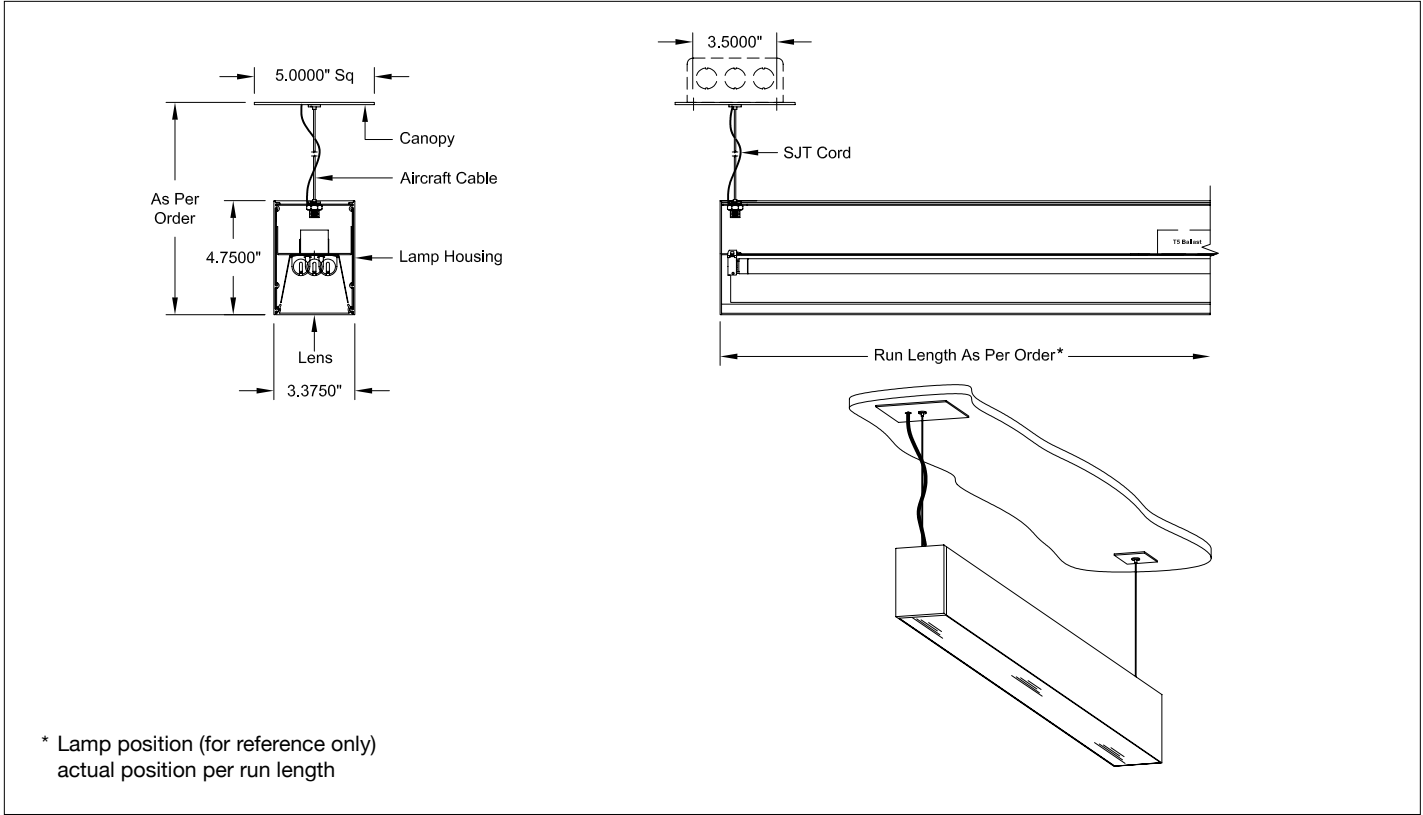

# of Fluor in Cross Section	Fluor Wattage	Ballast (Specify below)	Length (Nominal)	Voltage
<input type="checkbox"/> 1	See Configurations (Pages 2-3)	<input type="checkbox"/> E (Electronic) Std. <input type="checkbox"/> D (Dimming) †	<input type="checkbox"/> 24"	<input type="checkbox"/> 1 (120V)
<input type="checkbox"/> 2 - (24", 36", 48" and 60" only)			<input type="checkbox"/> 36"	<input type="checkbox"/> 2 (277V)
			<input type="checkbox"/> 48"	<input type="checkbox"/> 96"
			<input type="checkbox"/> 60"	<input type="checkbox"/> Custom (specify)

† Specify Ballast (required)

Description

Linear fluorescent direct pendant with flush snap-in lens. Single or double T5 lamps in cross section, as noted.

Features

- Standard Lens: Frosted acrylic
- Fixtures fabricated to any length (Refer to Pages 2-3)
- Continuous run length configurations with fully illuminated corners
- Access to ballast and wiring from bottom of fixture

Fixture Specifications

Finish: White (std), custom available
Weight: Approx. 4 lbs. per linear foot

Electrical

- Ambient temperature 100 °F. maximum
- Integral electronic ballast(s), thermally protected
- Through branch wiring capable

Mounting

Square canopies (std), round available.
Contact factory for special ceiling conditions.

Options (Consult factory)

- Occupancy sensor, daylight control module and EM pack
- Integrated downlight: MR16, MR16 LED
- Nippo, Feelux, or Lumilux Seamless lamping

Photometry: Consult factory



All designs and scale drawings shall remain the property of STARFIRE LIGHTING, INC., and may not be reproduced or transmitted without the expressed written consent. STARFIRE LIGHTING, INC. reserves the right to make changes on approved designs to facilitate manufacturing methods to the extent that such changes do not compromise design integrity.

Single Lamp Configurations

T5

PD4

Job Name: _____ Fixture Type: _____

- 1 - Choose fixture configuration
- 2 - Select desired fluorescent lamp wattage

Custom configurations upon request.

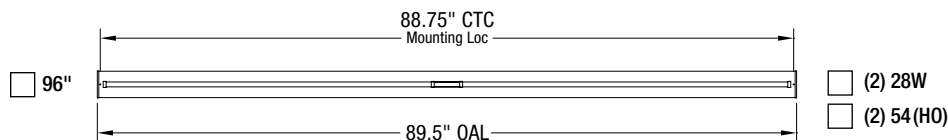
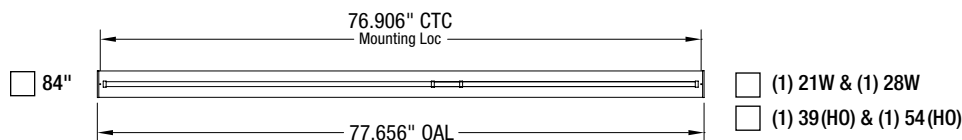
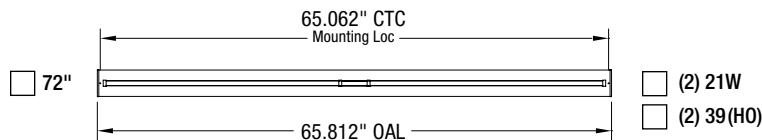
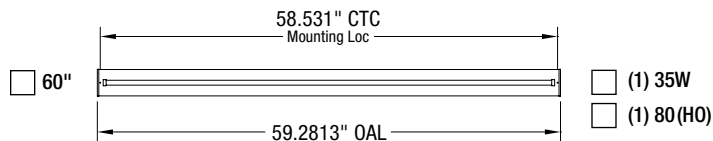
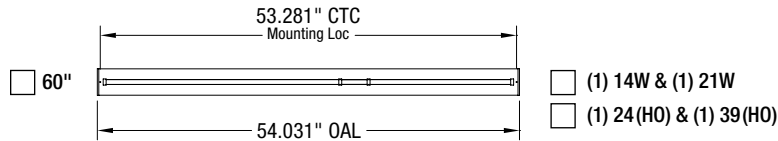
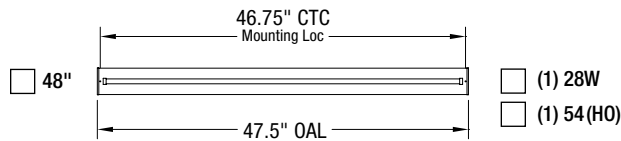
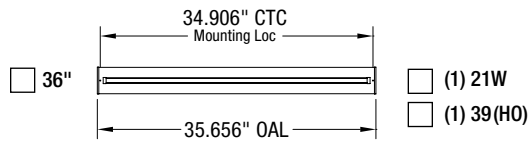
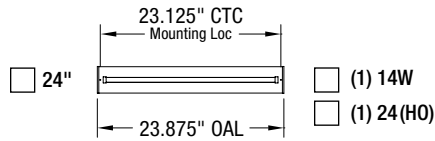

Starfire's patent pending EvenGlow™ system eliminates lamp/socket imaging and bright spots.

PD4

Job Name: _____ Fixture Type: _____

- 1 - Choose fixture configuration
- 2 - Select desired fluorescent lamp wattage

Custom configurations upon request.

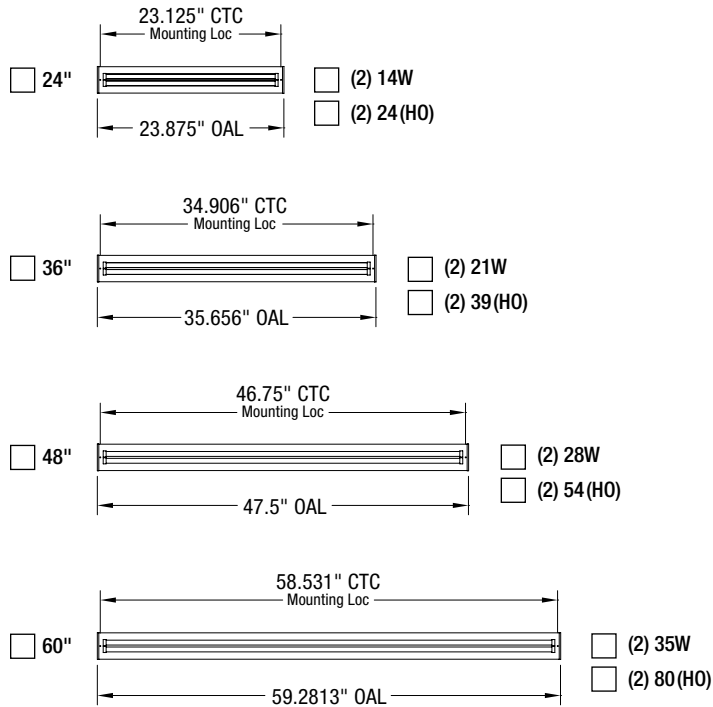

Starfire's patent pending EvenGlow™ system eliminates lamp/socket imaging and bright spots.