

Downlight, Flush Lens with Fixed Lamp

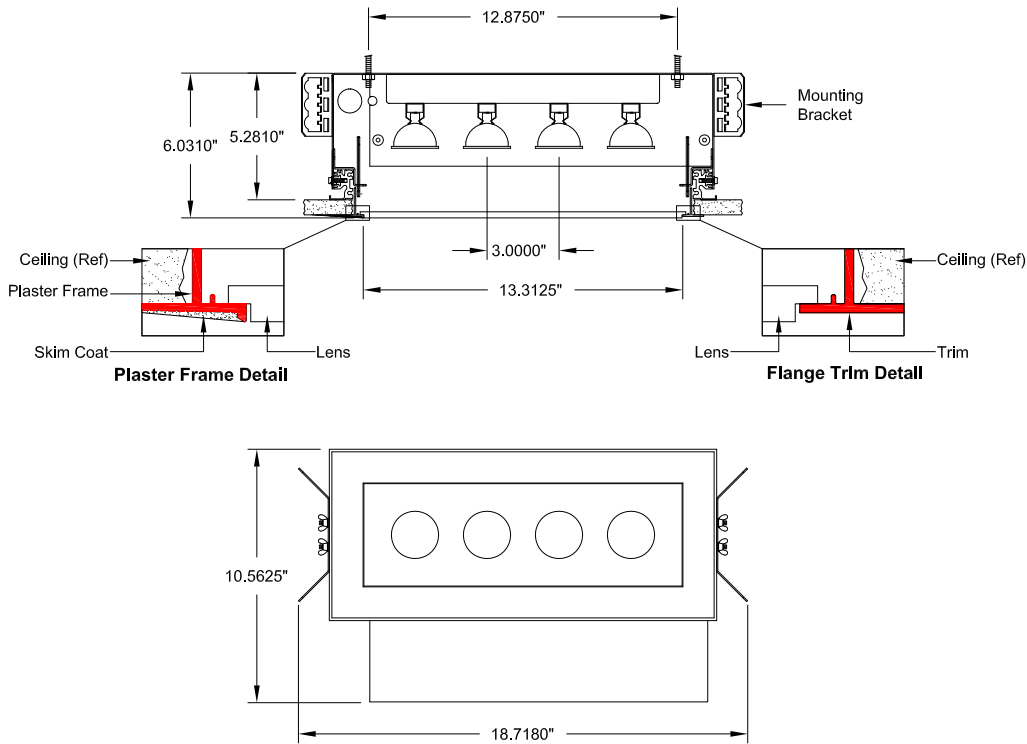

Ceiling Cut-out : 5.2500" x 14.2500" Trim Flange : 6.0625" x 15.0625" Aperture: 4.3125" x 13.3125"

-4-M6 - /W-FX-

Trim Type	Wattage	Trim Finish	Voltage
<input type="checkbox"/> VLP Plaster	<input type="checkbox"/> 20	<input type="checkbox"/> W White	<input type="checkbox"/> 1 (120V)
<input type="checkbox"/> VLF Flange	<input type="checkbox"/> 37	<input type="checkbox"/> B Black	<input type="checkbox"/> 2 (277V)
	<input type="checkbox"/> 50		

Description

Recessed downlight fixture with flush rabbeted lens. Fixed lampholders. Four MR16 lamps. Flanged or plaster frame trim.

Features

- Standard Lens: Solite
- Below ceiling access to the transformer and wiring.
- Plaster frame trim provides 0.062" reveal to minimize skim coat cracking.
- Integral Thermal Protection.

Fixture Specifications

Dimensions: 18.718"L x 10.562"W x 5.281"H
 Weight: Approx. 16 lbs.
 Ceiling Cutout: 14.25"L x 5.25"W

Electrical

- Power Consumption: 200 watts max.
- Ambient temperature 100 °F. maximum.
- Integral toroidal transformer.
- Through branch wiring capable.

Mounting

Universal mounting brackets included.
 Contact factory for special ceiling conditions.

Options (Consult factory)

- Lenses: Page 2
- Photometry: Page 3







All designs and scaled drawings shall remain the property of STARFIRE LIGHTING, INC., and may not be reproduced or transmitted without expressed written consent. STARFIRE LIGHTING, INC. reserves the right to make changes on approved designs to facilitate manufacturing methods to the extent that such changes do not compromise design integrity.

VL-4-M6

Job Name:

Fixture Type:

Lens Options

	Lenses		Cat. No.
<input type="checkbox"/>		Solite Spread Lens	S0
<input type="checkbox"/>		Frosted Solite Spread Lens	FS
<input type="checkbox"/>		Prismatic Spread Lens	PR
<input type="checkbox"/>		Frosted Prismatic Spread Lens	FP

For other lens options, consult factory.

VersaLux™ Series VL

Downlight, Flush Lens with Fixed Lamp

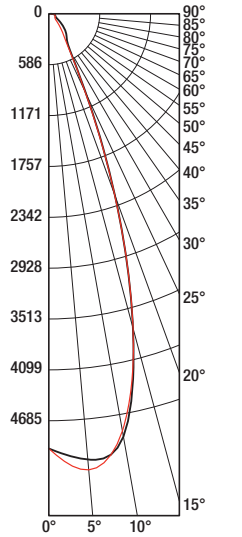

— 0° Plane — 90° Plane

4 Lamp Photometrics

50 Watt MR16, 38° Flood

Solite Lens

Photometry reports for other fixture configurations, consult factory

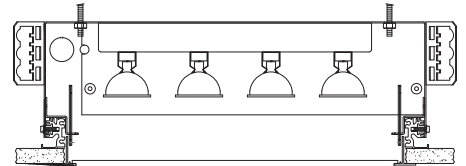

Total Luminaire Efficiency: 84.60%

Candela Distribution

	0	22.5	45	67.5	90
0	5005	5005	5005	5005	5005
5	5151	5224	5211	5267	5270
10	4943	4959	4975	4931	4877
15	3741	3730	3725	3711	3742
20	2224	2232	2219	2224	2211
25	1011	1004	1004	993	990
30	491	493	488	472	456
35	363	369	361	317	294
40	314	319	293	234	205
45	265	264	227	163	141
50	205	199	158	112	99
55	152	146	115	92	88
60	109	107	93	84	80
65	90	90	84	80	83
70	81	82	80	79	78
75	76	75	74	74	73
80	71	71	70	71	70
85	54	55	55	55	55
90	20	21	19	20	20

Zonal Lumen Summary

5	250
10	471
15	529
20	417
25	232
30	132
35	108
40	97
45	83
50	65
55	53
60	45
65	42
70	41
75	39
80	38
85	30
90	6

Utilization

RC	80				70				50			30			10			Flux
	70	50	30	10	70	50	30	10	50	30	10	50	30	10	50	30	10	
0	102	102	102	102	99	99	99	99	95	95	95	91	91	91	87	87	87	85
1	96	93	90	88	94	91	89	87	88	86	84	84	83	82	79	79	79	78
2	91	86	82	79	89	85	81	78	82	79	76	79	77	75	72	72	72	72
3	86	80	76	72	85	79	75	72	77	73	71	75	72	69	67	67	67	67
4	82	76	71	67	81	75	70	67	73	69	66	71	68	65	63	63	63	63
5	79	71	66	63	77	71	66	62	69	65	62	68	64	61	60	60	60	59
6	75	68	63	59	74	67	62	59	66	62	58	65	61	58	57	57	57	56
7	72	64	59	56	71	64	59	56	63	59	55	62	58	55	54	54	54	54
8	69	61	57	53	68	61	56	53	60	56	53	59	55	53	51	51	51	51
9	67	59	54	51	66	58	54	51	58	53	51	57	53	50	49	49	49	49
10	64	56	52	49	63	56	52	49	55	51	48	55	51	48	47	47	47	4