

## Downlight, Flush Lens with Virtual Pivot Lampholder

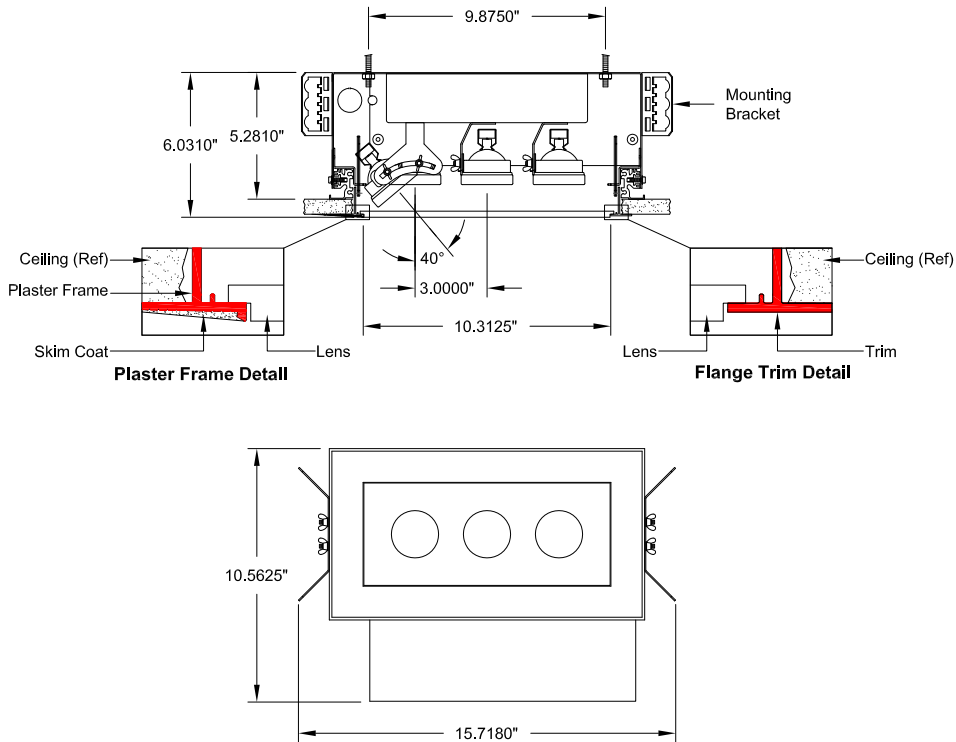

MR16



Ceiling Cut-out : 5.2500" x 11.2500"

Trim Flange : 6.0625" x 12.0625"

Aperture: 4.3125" x 10.3125"

Trim Type	Wattage	Trim Finish	Voltage
<input type="checkbox"/> VLP Plaster	<input type="checkbox"/> 20	<input type="checkbox"/> W White	<input type="checkbox"/> 1 (120V)
<input type="checkbox"/> VLF Flange	<input type="checkbox"/> 37	<input type="checkbox"/> B Black	<input type="checkbox"/> 2 (277V)
	<input type="checkbox"/> 50		

### Description

Recessed downlight fixture with flush rabbeted lens. Virtual pivot lampholders. Three MR16 lamps. Flanged or plaster frame trim.

### Features

- Standard Lens: Solite
- Below ceiling access to the transformer and wiring.
- Lampholders are adjustable from 0°-40°.
- Plaster frame trim provides 0.062" reveal to minimize skim coat cracking.
- Integral Thermal Protection.

### Fixture Specifications

Dimensions: 15.718"L x 10.562"W x 5.281"H  
 Weight: Approx. 14 lbs.  
 Ceiling Cutout: 11.25"L x 5.25"W

### Electrical

- Power Consumption: 150 watts max.
- Ambient temperature 100 °F. maximum.
- Integral toroidal transformer.
- Through branch wiring capable.

### Mounting

Universal mounting brackets included.  
 Contact factory for special ceiling conditions.

### Options (Consult factory)

- Lenses: Page 2
- Photometry: Page 3







All designs and scaled drawings shall remain the property of STARFIRE LIGHTING, INC., and may not be reproduced or transmitted without expressed written consent. STARFIRE LIGHTING, INC. reserves the right to make changes on approved designs to facilitate manufacturing methods to the extent that such changes do not compromise design integrity.

VL-3-M6

Job Name:

Fixture Type:

**Lens Options**

	Lenses		Cat. No.
<input type="checkbox"/>		Solite Spread Lens	S0
<input type="checkbox"/>		Frosted Solite Spread Lens	FS
<input type="checkbox"/>		Prismatic Spread Lens	PR
<input type="checkbox"/>		Frosted Prismatic Spread Lens	FP

For other lens options, consult factory.

# VersaLux™ Series VL

## Downlight, Flush Lens with Virtual Pivot Lampholder

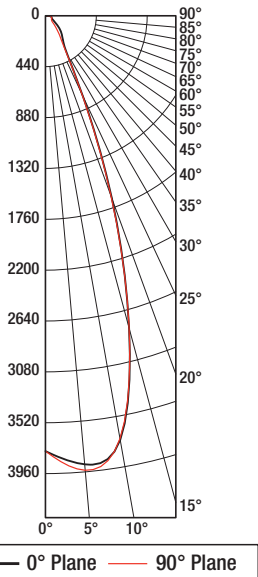

### 3 Lamp Photometrics

50 Watt MR16, 38° Flood

Solite Lens

Photometry reports for other fixture configurations, consult factory

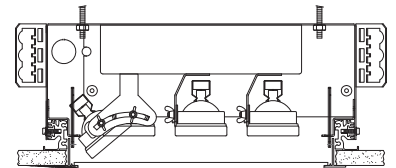

Total Luminaire Efficiency: 84.20%

#### Candela Distribution

	0	22.5	45	67.5	90
0	3766	3766	3766	3766	3766
5	3895	3886	3924	3960	3946
10	3725	3735	3698	3722	3714
15	2795	2801	2785	2804	2794
20	1679	1668	1662	1667	1657
25	759	750	751	743	746
30	365	364	362	351	344
35	268	274	270	238	223
40	222	230	217	175	154
45	188	189	166	122	105
50	144	143	113	83	74
55	105	104	85	68	65
60	80	76	69	62	60
65	64	63	63	59	58
70	60	60	60	59	59
75	55	55	56	54	55
80	52	54	53	52	54
85	40	40	41	41	41
90	14	15	14	15	15

#### Zonal Lumen Summary

5	187
10	354
15	397
20	312
25	174
30	98
35	81
40	71
45	60
50	47
55	38
60	33
65	31
70	31
75	29
80	29
85	22
90	4

#### Utilization

RC	80				70				50			30			10			Flux
	70	50	30	10	70	50	30	10	50	30	10	50	30	10	50	30	10	
0	101	101	101	101	99	99	99	99	94	94	94	90	90	90	87	87	87	85
1	95	93	90	88	93	91	88	86	87	85	84	84	83	81	78	78	78	77
2	90	86	82	79	88	84	81	78	81	79	76	79	77	75	72	72	72	71
3	86	80	76	72	84	79	75	71	77	73	70	75	72	69	67	67	67	67
4	82	75	71	67	80	74	70	66	73	69	66	71	68	65	63	63	63	63
5	78	71	66	63	77	70	66	62	69	65	62	67	64	61	60	60	60	59
6	75	67	63	59	74	67	62	59	66	61	58	64	61	58	56	56	56	56
7	72	64	59	56	71	64	59	56	63	58	55	62	58	55	54	54	54	54
8	69	61	56	53	68	61	56	53	60	56	53	59	55	53	51	51	51	51
9	66	59	54	51	65	58	54	51	57	53	51	57	53	50	49	49	49	49
10	64	56	52	49	63	56	52	49	55	51	48	55	51	48	47	47	47	4