

Downlight, Flush Lens with Fixed Lamp

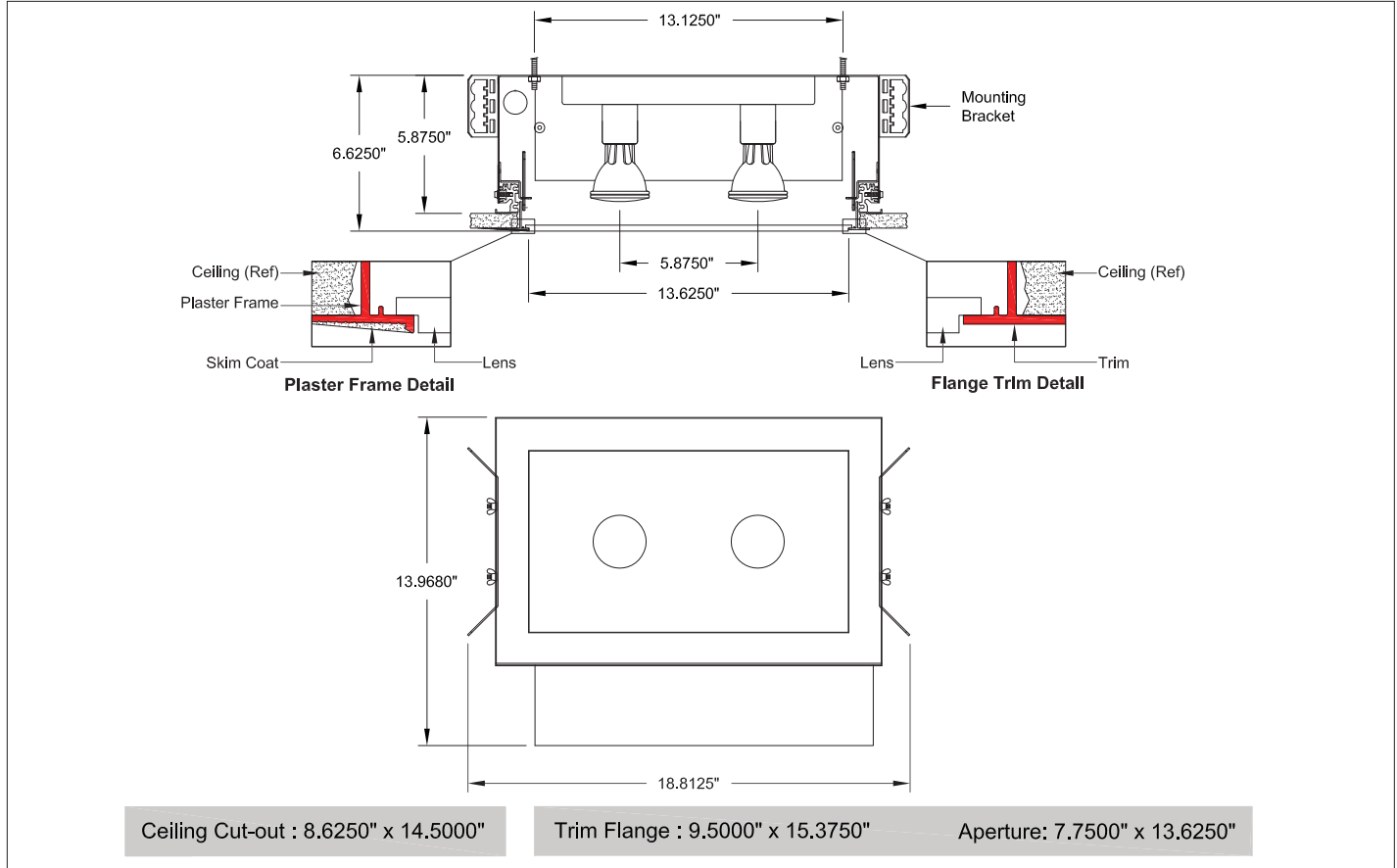

PAR20 MH



-2-P2M - /W-FX-

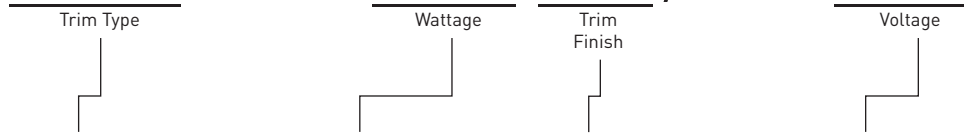

Trim Type	Wattage	Trim Finish	Voltage
<input type="checkbox"/> VLP Plaster	<input type="checkbox"/> 20	<input type="checkbox"/> W White	<input type="checkbox"/> 1 (120V)
<input type="checkbox"/> VLF Flange	<input type="checkbox"/> 39	<input type="checkbox"/> B Black	<input type="checkbox"/> 2 (277V)

Description

Recessed metal halide downlight fixture with flush rabbeted lens. Fixed lampholders. Two PAR20 MH lamps. Flanged or plaster frame trim.

Features

- Standard Lens: Solite
- Below ceiling access to the ballast and wiring.
- Plaster frame trim provides 0.062" reveal to minimize skim coat cracking.
- Integral Thermal Protection.

Fixture Specifications

Dimensions: 18.812"L x 13.968"W x 5.875"H
 Weight: Approx. 14 lbs.
 Ceiling Cutout: 14.5"L x 8.625"W

Electrical

- Power Consumption: 78 watts max.
- Ambient temperature 100 °F. maximum.
- Integral electronic ballast.
- Through branch wiring capable.

Mounting

Universal mounting brackets included.
 Contact factory for special ceiling conditions.

Options (Consult factory)

- Lenses: Page 2

Photometry: Page 3







All designs and scaled drawings shall remain the property of STARFIRE LIGHTING, INC., and may not be reproduced or transmitted without expressed written consent. STARFIRE LIGHTING, INC. reserves the right to make changes on approved designs to facilitate manufacturing methods to the extent that such changes do not compromise design integrity.

VL-2-P2M

Job Name:

Fixture Type:

Lens Options

	Lenses		Cat. No.
<input type="checkbox"/>		Solite Spread Lens	S0
<input type="checkbox"/>		Frosted Solite Spread Lens	FS
<input type="checkbox"/>		Prismatic Spread Lens	PR
<input type="checkbox"/>		Frosted Prismatic Spread Lens	FP

For other lens options, consult factory.

VersaLux™ Series VL

Downlight, Flush Lens with Fixed Lamp

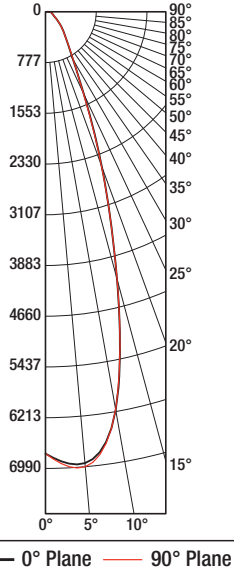

2 Lamp Photometrics

35 Watt PAR20 Metal Halide, 30° Flood

Solite Lens

Photometry reports for other fixture configurations, consult factory

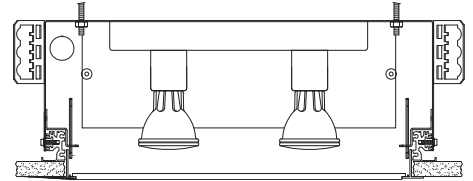

Total Luminaire Efficiency: 91.40%

Candela Distribution

	0	22.5	45	67.5	90
0	6764	6764	6764	6764	6764
5	6934	6921	6845	6918	6990
10	6188	6185	6168	6201	6181
15	4221	4238	4206	4236	4226
20	2517	2511	2491	2483	2499
25	1386	1384	1374	1372	1366
30	844	855	849	844	853
35	597	600	606	600	600
40	458	463	454	457	454
45	366	358	362	359	362
50	282	281	283	282	281
55	217	221	219	220	219
60	173	170	171	172	170
65	136	136	138	134	140
70	122	119	120	120	119
75	103	106	105	107	104
80	99	99	100	98	99
85	77	77	78	76	76
90	30	28	26	27	26

Zonal Lumen Summary

5	330
10	589
20	468
25	319
30	233
35	189
40	161
45	140
50	118
55	99
60	81
65	68
70	62
75	56
80	53
85	42
90	8

Utilization

RC	80				70				50			30			10			Flux
	70	50	30	10	70	50	30	10	50	30	10	50	30	10	50	30	10	
0	109	109	109	109	107	107	107	107	102	102	102	98	98	98	94	94	94	92
1	103	100	97	94	101	98	95	93	94	92	90	90	89	87	84	84	84	83
2	97	92	88	84	95	90	86	83	87	84	81	84	82	79	77	77	77	76
3	92	85	80	76	90	84	79	75	82	78	74	79	76	73	71	71	71	70
4	87	80	74	70	86	79	74	70	77	72	69	75	71	68	66	66	66	66
5	83	75	69	65	82	74	69	65	72	68	64	71	67	64	62	62	62	62
6	79	71	65	61	78	70	65	61	69	64	60	67	63	60	58	58	58	58
7	76	67	61	57	75	66	61	57	65	60	57	64	60	57	55	55	55	55
8	73	64	58	54	71	63	58	54	62	57	54	61	57	54	52	52	52	52
9	70	61	55	52	69	60	55	52	59	55	51	59	54	51	50	50	50	50
10	67	58	53	49	66	58	53	49	57	52	49	56	52	49	48	48	48	4